

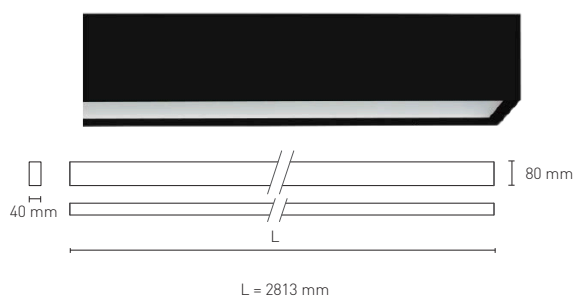

NEXIA

INFINITY TRIMLESS MICROPRISMATIC

Luminaria LED en extrusión de aluminio sin marco para empotrar, suspender o adosar a techo equipada con difusor micro-prismático.



16120 -					
	Color	CRI / Temp.	Led	Regulación	Clase
0	Blanco	C 830	L Low Output: 8300 lm / 62 W	D Dali	I
1	Negro	N 840	H High Output: 15250 lm / 115 W		
2	Gris				

5750g	1	IP 20	CRI=80	50.000 h	230 V	DRIVER	LED	SMD	70°	Difusor microprismático
-------	---	-------	--------	----------	-------	--------	-----	-----	-----	-------------------------

DESCRIPCIÓN

Luminaria lineal con perfilera de extrusión en aluminio sin ala (trimless) para adosar, empotrar o suspender. La versión DOWN no requiere accesorios.

UGR < 18.5 sólo en versión Low Output.

INSTALACIÓN

La versión DOWN no requiere accesorios. Para versiones suspendida y empotrada ver accesorios en página 2.

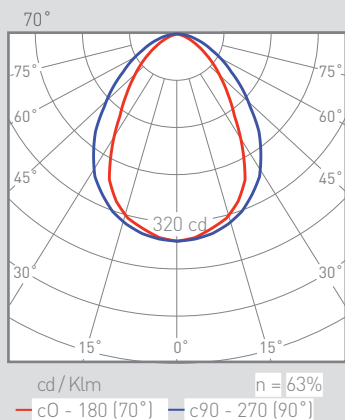

CERTIFICADOS DE CALIDAD:

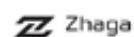



NEXIA

ACCESORIOS PARA INFINITY TRIMLESS SUSPENSIÓN

TRIMLESS-AIR

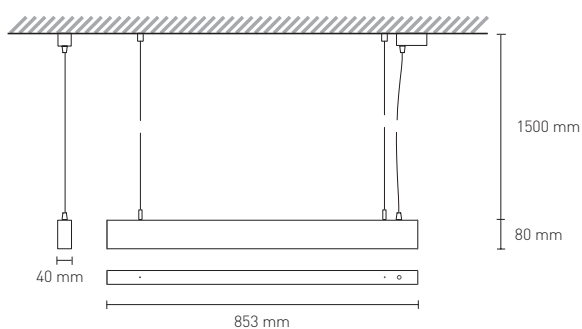

17935 - CABLE DE SUSPENSIÓN 1500 mm (2 ud.)

17936 - CABLE DE SUSPENSIÓN 2500 mm (2 ud.)



17941 - BASE INFINITY 1500 mm 3 cables

17942 - BASE INFINITY 1500 mm 5 cables

17943 - BASE INFINITY 2500 mm 3 cables

17944 - BASE INFINITY 2500 mm 5 cables

Color

0	Blanco	
1	Negro	
2	Gris	

ACCESORIOS PARA INFINITY TRIMLESS EMPOTRABLE



17981 - ACCESORIOS PARA VERSIÓN EMPOTRABLE

Unidades necesarias de accesorio para empotrar	2 ud.	3 ud.	4 ud.
16102 / 16112 - 573 x 40 mm	x		
16103 / 16113 - 853 x 40 mm	x		
16104 / 16114 - 1133 x 40 mm	x		
16105 / 16115 - 1413 x 40 mm		x	
16106 / 16116 - 1693 x 40 mm		x	
16107 / 16117 - 1973 x 40 mm		x	
16109 / 16119 - 2533 x 40 mm			x
16110 / 16120 - 2813 x 40 mm			x

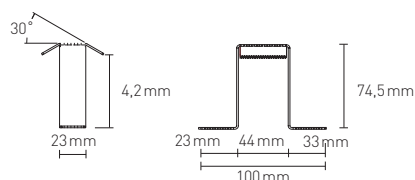

CERTIFICADOS DE CALIDAD:

