

## PRODUCT DESCRIPTION

- Designed to reach an IP67 waterproof rating
- Masks the edges of the groove
- Recessed shallow housing for LED strips up to 10 mm wide (0.39")

### FINISH :

Silver anodized 

\*Custom colors available upon request



Fill empty fields

Product nr.

Fixture type

Company

Job name

Date

## TECHNICAL SPECIFICATION

### Application

- construction of lighting fixtures incorporated as furniture lighting

### Mounting

- with mounting adhesive and professional double-sided adhesive tapes

### Additional information

- possibility of making a linear fixture with IP67 protection, which means the fixture is dustproof and waterproof
- space for LED strip: 11.2 mm

### Profile bending

Minimum internal radius	Minimum external radius
150 mm	150 mm

- minimum radius - bending radius which when exceeded causes destruction (deformation, bending or lack of compatibility with other accessories, e.g. covers, end caps, etc.) of the profile
- internal radius - refers to the profile bent so that the cover is facing the inside of the arch
- external radius - refers to the profile bent so that the cover is facing the outside of the arch
- irregular curves are possible after consultation and individual quotation
- when bending anodized profiles, one should be aware of cracking of the anode coating (which may be more or less visible depending on the radius)

### Line of light

✓ = Line of Light  
X = Visible dotting

Profile:	LED Model:	HS/HS-12/HS-22 frosted	Liger/Liger-22 frosted	Liger/Liger-22 black	KA frosted	KA-PRO frosted	M-K frosted
MICRO-K							
	1210	X	X	X	X	X	X
	1220	X	X	X	X	X	X
	1275	X	X	X	X	X	✓
	0530	X	X	X	X	X	✓
	1910	X	X	X	X	X	✓
	1820	X	✓ (Hot line)	X	X	X	✓

**AVAILABLE LENGTHS**

Ref. nr.	surface finish	available lengths
B3775ANODA_1	Silver anodized	1000 mm
B3775ANODA_2	Silver anodized	2000 mm
B3775ANODA_3	Silver anodized	3000 mm

**TECHNICAL DRAWING**

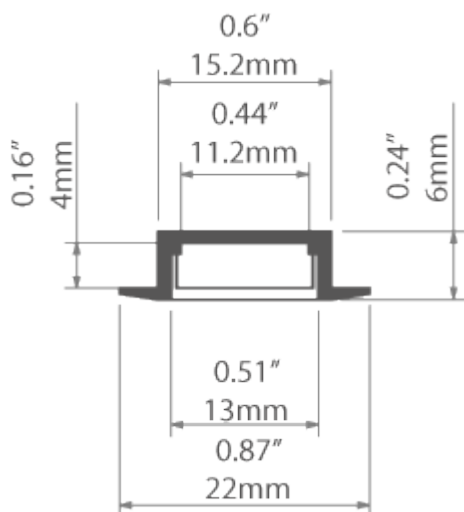

**RELATED PRODUCTS**

**COVERS**

**BLACK COVERS**

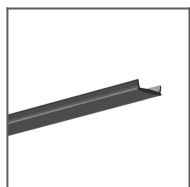

LIGER black Cover

Ref: 17040

90°

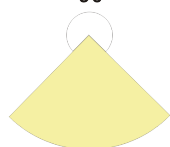

**CLEAR COVERS**

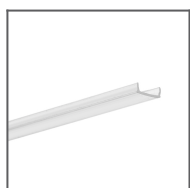

KA clear Cover

Ref: 17036

110°

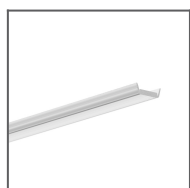

HS clear Cover

Ref: 1370

110°

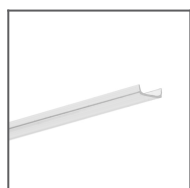

KA-COM clear Cover

Ref: 17122

100°

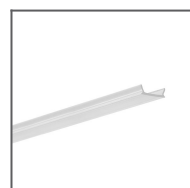

KA-PRO clear Cover

Ref: 17065

100°



**FROSTED COVERS**

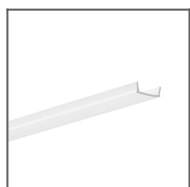

KA frosted Cover

Ref: 17035

110°

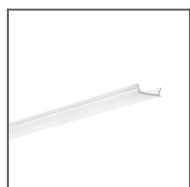

KA-PRO frosted Cover

Ref: 17064

110°

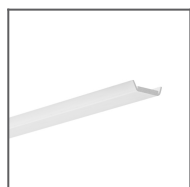

HS frosted Cover

Ref: 1369

110°

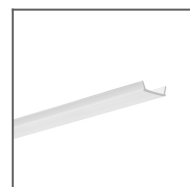

KA-COM frosted Cover

Ref: 17121

110°

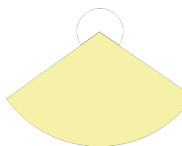

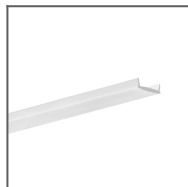

LIGER frosted Cover  
Ref: 17037

120°



## END CAPS

### REGULAR END CAPS

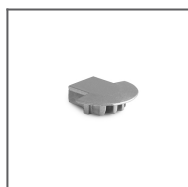

MICRO-K  
metalized End  
cap  
Ref: 24060



MICRO-K grey End  
cap  
Ref: 1430



MICRO-K white  
End cap  
Ref: 20004

### REGULAR END CAPS WITH HOLE

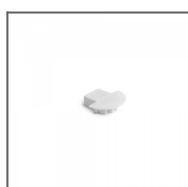

MICRO-K-OTW  
End cap  
Ref: 21004



MICRO-K-OTW  
grey End cap  
Ref: 1448

### MICRO SWITCH WITH HOLE



MICRO-K-MW grey  
End cap  
Ref: 00025



MICRO-K-MW-OTW  
white End cap  
Ref: 23004



MICRO-K-OTW-MW  
grey End cap  
Ref: 00308

## ACCESSORIES

SEALING COMPONENTS



6 x 1.2 Gland  
Ref: 00802

LED TAPES

WHITE

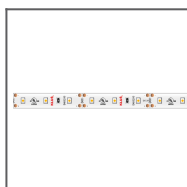

LED strip K-1210-12V  
Ref: K-1210-12V

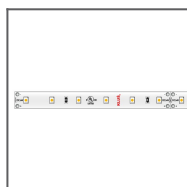

LED strip K-1210-24V  
Ref: K-1210-24V

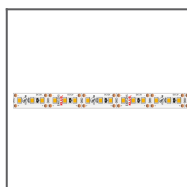

LED strip K-1220-12V  
Ref: K-1220-12V

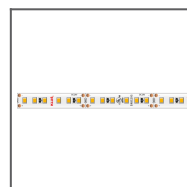

LED strip K-1220-24V  
Ref: K-1220-24V

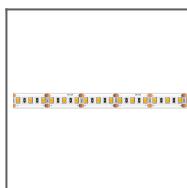

LED strip K-1275-12V  
Ref: K-1275-12V



LED strip K-1275-24V  
Ref: K-1275-24V

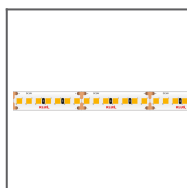

LED strip K-1820-HD-24V  
Ref: K-1820-HD-24V



LED strip K-1910-HD-24V  
Ref: K-1910-HD-24V

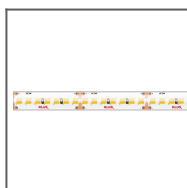

LED strip WP-K-1640-HD-IP65-24V  
Ref: WP-K-1640-HD-IP65-24V

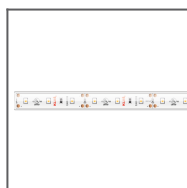

LED strip WP-K-1210-12V  
Ref: WP-K-1210-12V

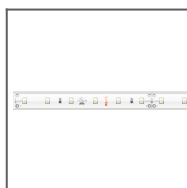

LED strip WP-K-1210-24V  
Ref: WP-K-1210-24V

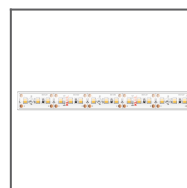

Taśma LED WP-K-1220-12V  
Ref: WP-K-1220-12V

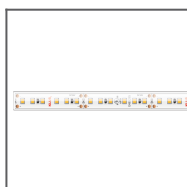

LED strip LED WP-K-1220-24V  
Ref: WP-K-1220-24V

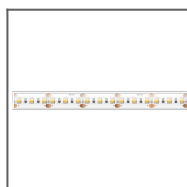

LED strip WP-K-1275-12V  
Ref: WP-K-1275-12V

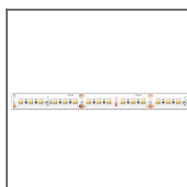

LED strip WP-K-1275-24V  
Ref: WP-K-1275-24V

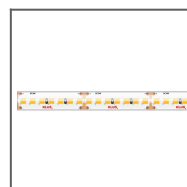

Taśma LED WP-K-1910-HD-IP65-24V  
Ref: WP-K-1910-HD-IP65-24V

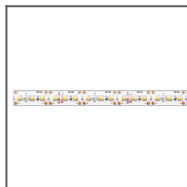

LED strip WP-K-1220-IP65-12V  
Ref: WP-K-1220-IP65-12V



LED strip WP-K-1220-IP65-24V  
Ref: WP-K-1220-IP65-24V

**CRI 95+**



LED strip WP-K-CR-1210-24V  
Ref: WP-K-CR-1210-24V

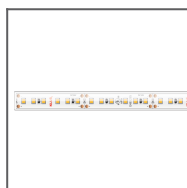

LED strip WP-K-CR-1220-24V  
Ref: WP-K-CR-1220-24V

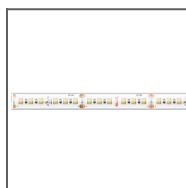

LED strip WP-K-CR-1275-24V  
Ref: WP-K-CR-1275-24V

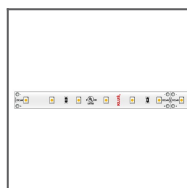

LED strip K-CR-1210-24V  
Ref: K-CR-1210-24V



LED strip K-CR-1220-24V  
Ref: K-CR-1220-24V



LED strip K-CR-1275-24V  
Ref: K-CR-1275-24V

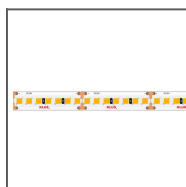

LED strip K-CR-1820-HD-24V  
Ref: K-CR-1820-HD-24V



LED strip K-CR-1910-HD-24V  
Ref: K-CR-1910-HD-24V

**LONG RUN**

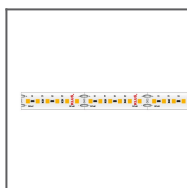

LED strip K-LR-1000-24V  
Ref: K-LR-1000-24V

**RGB / RGB-W**

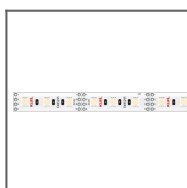

LED strip K-1275-RGB-12V  
Ref: K-1275-RGB-12V

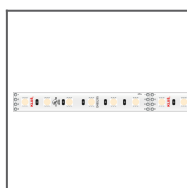

LED strip K-1275-RGB-24V  
Ref: K-1275-RGB-24V

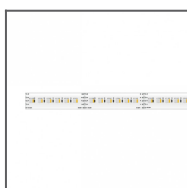

LED strip K-1530-RGB+W-24V  
Ref: K-1530-RGB+W-24V

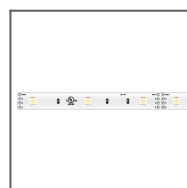

LED strip K-1215-RGB-12V  
Ref: K-1215-RGB-12V

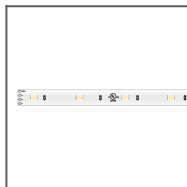

LED strip K-1215-  
RGB-24V  
Ref: K-1215-12V

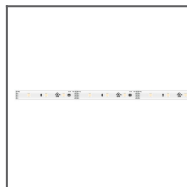

LED strip K-1225-  
RGB-12V  
Ref: K-1225-  
RGB-12V

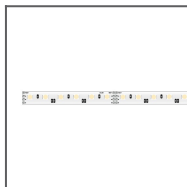

LED strip K-1225-  
RGB-24V  
Ref: K-1225-  
RGB-24V

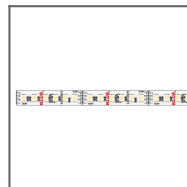

LED strip  
K-1920-120-12V  
19.2W/m  
Ref: K-1920-120-  
RGB-24V

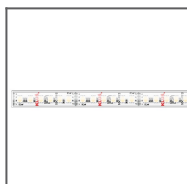

LED strip WP-  
K-1920-120-12V  
Ref: WP-K-1920-120-  
RGB-24V

#### TUNABLE WHITE / DIM TO WARM

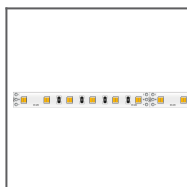

LED strip  
K-27/65-1920-24V  
Ref:  
K-27/65-1920-24V



LED strip WP-  
K-27/65-1920-24V  
Ref: WP-  
K-27/65-1920-24V

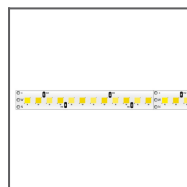

LED strip  
K-22/50-1728-24V  
Ref:  
K-22/50-1728-24V

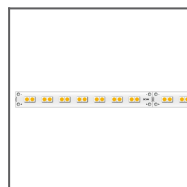

LED strip  
K-30/18-1770-24V  
Ref:  
K-30/18-1770-24V

#### MARKETING MATERIALS



Presentation set 1  
Ref: 90051